

HORUS

MAISON FRANÇAISE DE ROBINETTERIE



Tarif 2017 | Price list 2017

Finitions usuelles Finishes

Voir prix dans chacune des collections (pages 8 à 193)
See prices of each range (page 8 to 193)



CH

Chrome
Chrome



NB

Nickel Brillant
Polished Nickel



NM

Nickel Mat
Brushed Nickel

Finitions Décoration Finishes Decoration

Voir table de correspondance ci-contre
See cross references



BM

Bronze Mat Vernis Brillant
Antikbrass Gloss Varnish



VC

Vieux Cuivre Vernis Brillant
Old Copper Gloss Varnish



PB

Polishbrass Vernis Brillant
Polished Brass Gloss



SG

Argent Brillant
Polished Silver



DO

Doré Brillant
Gold Gloss



BV

Bronze Mat Vernis Mat
Antikbrass Matt Varnish
Prix / Price = **BM** + 10 %



CM

Vieux Cuivre Vernis Mat
Old Copper Matt Varnish
Prix / Price = **VC** + 10 %



VB

Vieux Bronze Vernis Mat
Old Bronze Matt Varnish



AV

Vieil Argent
Old Silver
Prix / Price = **SG** + 10 %



DM

Doré Mat
Gold Matt
Prix / Price = **DO** + 10 %

Porcelaine Porcelain

PC

Porcelaine
Porcelain

Standard :



Blanc White

Option / Ebenfalls erhältlich :



Pastilles métal - toutes finitions
Metal indices - all finishes

Table de correspondance

Cross references

Tableau de correspondance des prix pour les finitions décoration
Cross references for finishes decoration's prices

Collections	BM	VC	VB	PB	SG	DO
	Bronze Mat Vernis Brillant Antikbrass Gloss	Vieux Cuivre Vernis Brillant Old Copper Gloss	Vieux Bronze Old Bronze	Polishbrass Polished Brass	Argent Brillant Polished Silver	Doré Vernis Brillant Gold Gloss
01 Julia / 19 Victoria	CH x 1,50	CH x 1,50	CH x 1,70	CH x 1,70	CH x 1,85	CH x 1,85
02 Eloïse	CH x 1,50	CH x 1,50	CH x 1,70	CH x 1,70	CH x 1,85	CH x 1,85
07 - 50 Montmartre	CH x 1,50	CH x 1,50	CH x 1,70	CH x 1,70	CH x 1,85	CH x 1,85
06 - 10 Anthea	CH x 1,50	CH x 1,50	CH x 1,70	CH x 1,70	CH x 1,85	CH x 1,85
28 Coventry	CH x 1,50	CH x 1,50	CH x 1,70	CH x 1,70	CH x 1,85	CH x 1,85
20 - 62 - 65 Ascott	CH x 1,50	CH x 1,50	CH x 1,70	CH x 1,70	CH x 1,85	CH x 1,85

Cuisine Kitchen

01 Julia / 19 Victoria	CH x 1,50	CH x 1,50	CH x 1,70	CH x 1,70	CH x 1,85	CH x 1,85
01 Taverne	CH x 1,50	CH x 1,50	CH x 1,70	CH x 1,70	CH x 1,85	CH x 1,85
02 Eloïse	CH x 1,50	CH x 1,50	CH x 1,70	CH x 1,70	CH x 1,85	CH x 1,85
07-50 Montmartre	CH x 1,50	CH x 1,50	CH x 1,70	CH x 1,70	CH x 1,85	CH x 1,85

Complément

Lave-mains Handbasin	CH x 1,50	CH x 1,50	CH x 1,70	CH x 1,70	CH x 1,85	CH x 1,85
Douche Shower	CH x 1,50	CH x 1,50	CH x 1,70	CH x 1,70	CH x 1,85	CH x 1,85
Accessoires Accessories	CH x 1,50	CH x 1,50	CH x 1,70	CH x 1,70	CH x 1,85	CH x 1,85

Siphons / Vidages Traps / Wastes	CH x 1,50	CH x 1,50	CH x 1,70	CH x 1,70	CH x 1,85	CH x 1,85
-------------------------------------	-----------	-----------	-----------	-----------	-----------	-----------

Liste non exhaustive, pour toute autre finition décoration sur demande : nous consulter
Non exhaustive list, any other finishes decoration on request: contact us

Exemple de correspondance du prix H.T. pour 01.708 (Mitigeur lavabo Julia - Page 84) :







$$01.708 \text{ BV} = 01.708 \text{ CH} (410 \text{ €}) \times 1,50 + 10\% = \mathbf{677 \text{ €}}$$

Example: correspondant price H.T. for 01.708 (Basin mixer Julia - Page 84) :

$$01.708 \text{ BV} = 01.708 \text{ CH} (410 \text{ €}) \times 1,50 + 10\% = \mathbf{677 \text{ €}}$$

Divers

Diverse

			Prix H.T Price
Réf. 00.465		<p>Flexible de rechange 200 cm + raccord flexible tressé Inox 50 cm 1 x conique 1/2\" + 1 x hexagonal 1/2\" avec écrou tournant côté douchette</p> <p>Spare flexible hose 200 cm with connecting hose inox 50 cm 1 x 1/2\" conic and 1 x 6 edges 1/2\" with swivelling nut on handshower side</p>	<p>CH 51 € NB 58 € NM 69 € BM/VC 84 € PB 156 € DO/VB 156 €</p>
Réf. 00.585		<p>Flexible de rechange 150 cm avec écrou 1 x 6 pans 1/2\" + 1 x conique 1/2\" avec écrou tournant côté douchette</p> <p>Spare flexible hose 150 cm with nuts 1 x 6 edges 1/2\" + 1 x 1/2\" conic with swivelling nut on handshower side</p>	<p>CH 45 € NB 52 € NM 64 € BM/VC 76 € PB 127 € DO/VB 127 €</p>
Réf. 28.547		<p>Flexible de rechange 150 cm pour 28.516 UNIQUEMENT avec écrou tournant côté douchette</p> <p>Spare flexible hose 150 cm for 28.516 ONLY with swivelling nut on handshower side</p>	<p>CH 65 € NB 74 € NM 90 € BM/VC 98 € PB/VB 110 € DO 119 €</p>
Réf. 46.465		<p>Flexible apparant 200 cm avec écrou tournant anti-torsion 1 x 6 pans 1/2\" + 1 x conique 1/2\"</p> <p>Exposed flexible hose 200 cm with swivelling nut anti twisting 1 x 6 edges 1/2\" + 1 x 1/2\" conic</p>	<p>CH 55 € NB 61 € NM 73 € BM/VC 78 € PB/VB 121 € DO 121 €</p>
Réf. B00 6751		<p>Flexible plastique chromalux 150 cm avec écrou tournant côté douchette</p> <p>Plastic flexible hose chromalux 150 cm with swivelling nut on handshower side</p>	<p>CH 33 €</p>
Réf. 01.617		<p>Robinet d'arrêt 3/8\", également disponible en 1/2\" Angle stopcock 3/8\"</p>	<p>CH 108 € NB 113 € NM 120 € BM/VC 161 € PB/VB 185 € DO 200 €</p>

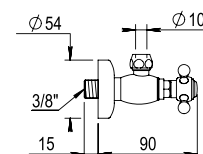

Divers Diverse

Réf. **01.627**



Kit d'alimentation pour chasse WC comprenant : robinet d'arrêt + tube L. 300 mm + rosace + écrou 1/2"

Outlet kit for WC including : stopcock + pipe 300 mm + flange + 1/2" screw-nut

Prix H.T
Price

CH	173 €
NB	198 €
NM	243 €
BM/VC	259 €
PB/VB	294 €
DO	320 €

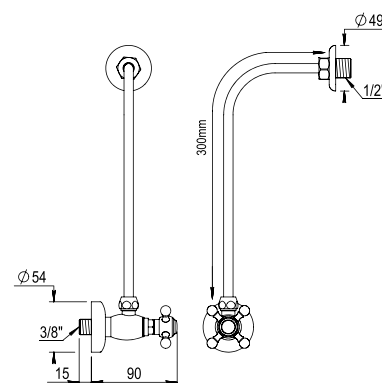

Réf. **00.835**



Tube d'adduction diam. 10 mm, longueur 300 mm

Pipe diam. 10 mm, length 300 mm

CH	23 €
NB	28 €
NM	33 €
BM/VC	35 €
PB/VB	40 €
DO	43 €

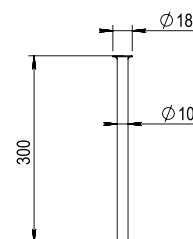

Réf. **00.843**



Cache-trou lisse pour lavabo, bidet, etc ø 40 mm

Hole stop smooth diam. 40 mm - for basin/bidet...

CH	23 €
NB	28 €
NM	33 €
BM/VC	35 €
PB/VB	40 €
DO	43 €

Réf. **00.844**



Cache-trou porte chaînette pour lavabo, bidet, etc ø 40 mm

Hole stop with chain stay diam. 40 mm - for basin/bidet...

CH	41 €
NB	47 €
NM	59 €
BM/VC	63 €
PB/VB	70 €
DO	75 €

Réf. **00.589**



Douchette à main pour toilette, sortie par support, crochet auto-stop, flexible

Handspray for toilet with hose on supply stop hook

CH	237 €
NB	248 €
NM	272 €

